

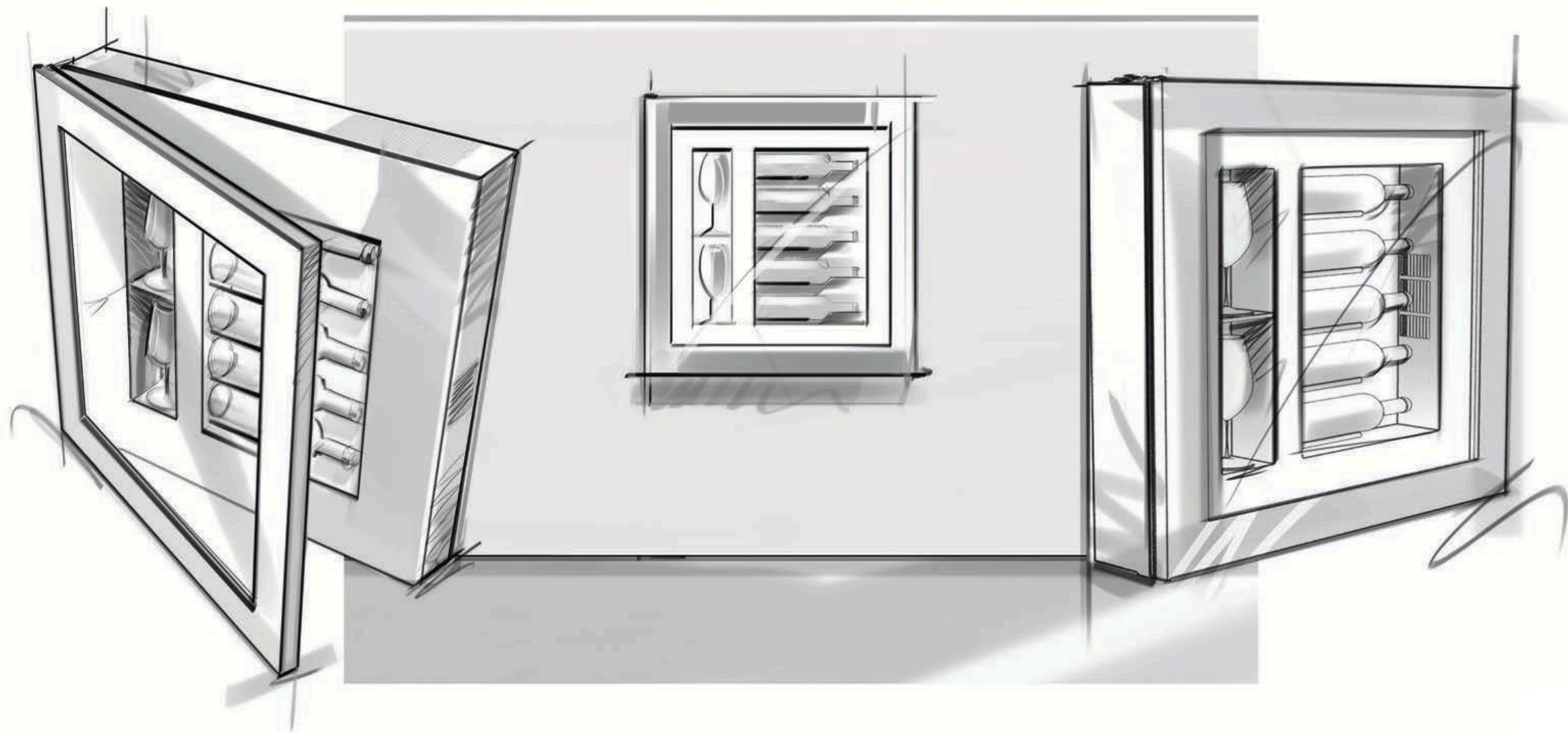

# Quadro Vino



DELLA MARTA  
ITALY  
  
GASTRÓMA



Q

## Quardo Vino

Design och teknologi förenas för att skapa världens första kylda tavla. Detta unika inredningsobjekt gör det möjligt att elegant visa upp dina mest värdefulla flaskor och samtidigt förhöja och lyfta fram miljön där den placeras. Quadro Vino är världens första kylskåp som, likt en tavla, kan hängas upp ovanför en soffa. Det är skapat för att göra de mest speciella stunderna ännu mer minnesvärda och skapa oväntade känslor.

Design and technology unite to create the world's first refrigerated artwork. This unique piece of furniture allows you to elegantly display your most valuable bottles while enhancing and highlighting the environment in which it is placed. Quadro Vino is the world's first refrigerator that, like a painting, can be hung above a sofa. It is designed to make the most special moments even more memorable and evoke unexpected emotions.





QV12

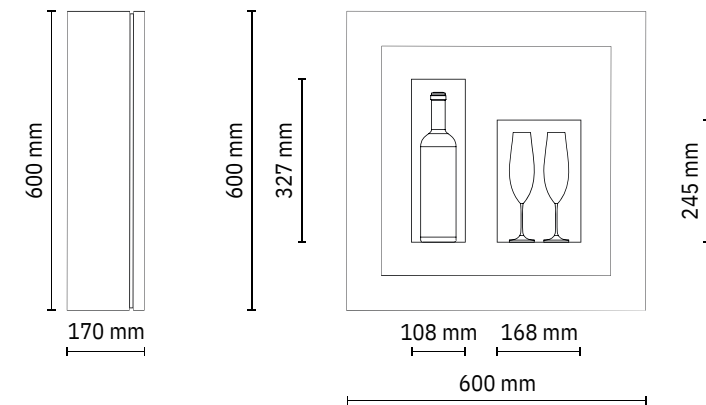

°C  
+ 4 / +10



Quadro Vino n. 12



Quadro Vino n. 30



QV30

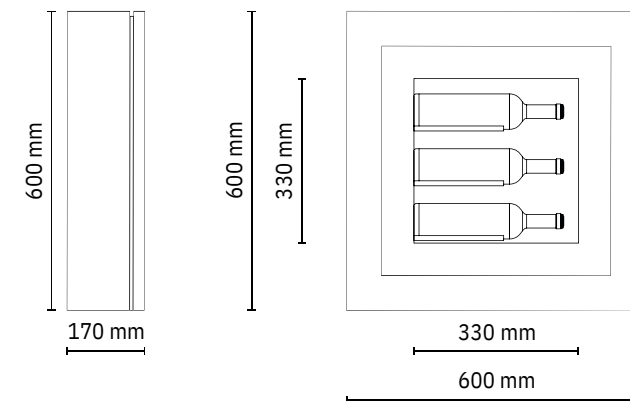

 °C  
+ 8 / +20



Quadro Vino n. 30



Quadro Vino n. 30



QV40

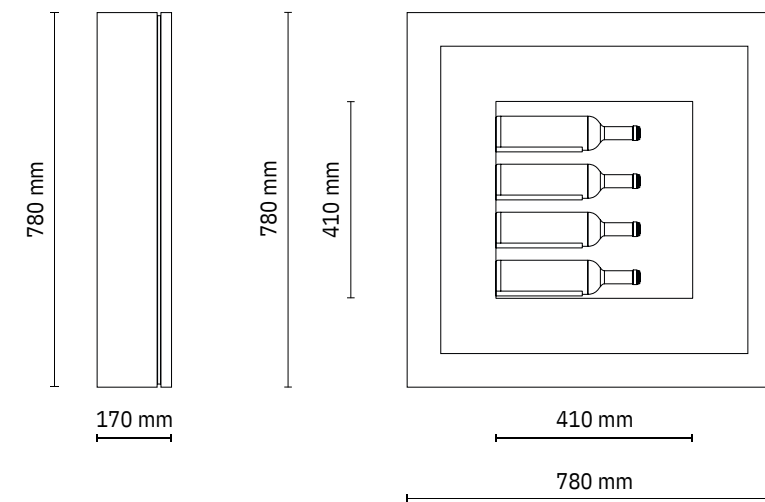

°C  
+ 12 / +20

Quadro Vino n. 40

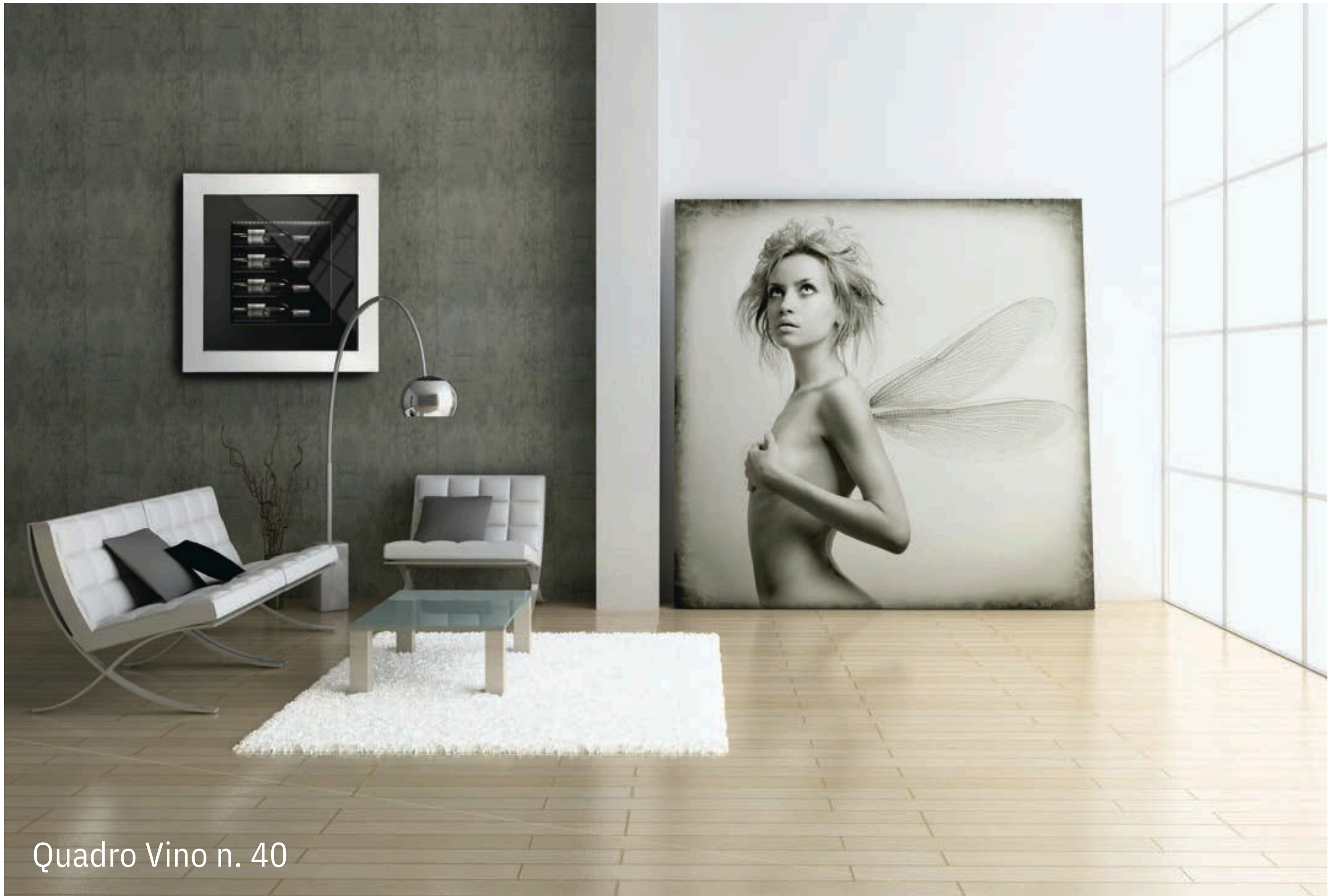

Quadro Vino n. 40



Quadro Vino n. 40



Quadro Vino n. 40



Quadro Vino n. 52



QV52

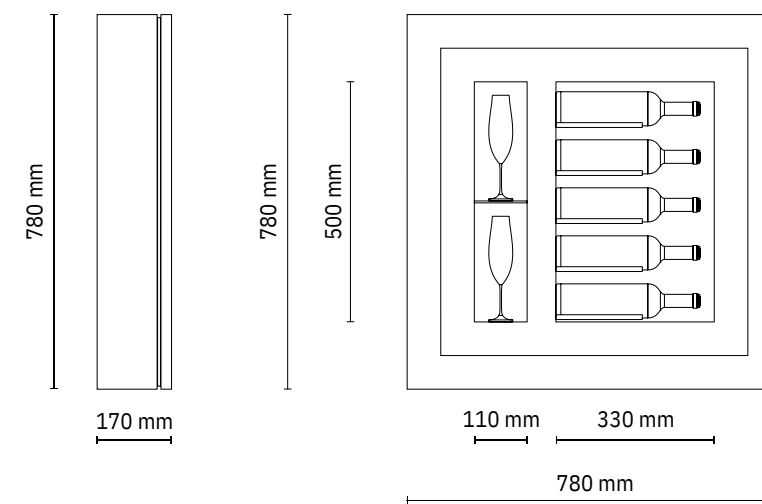

°C  
+ 12 / +20

Quadro Vino n. 52





Quadro Vino n. 52



Quadro Vino n. 52

# Quadro Vino

## TEKNISKA SPECIFIKATIONER

Specifications

Struktur i metall / Dörrstruktur i aluminium / Ram i trä /  
HPL / MDF 20 mm isolerglas / magnetisk tätning /  
Inre panel i stål / Belysning med naturligt vitt LED-ljus  
(4000 K - 60 LED/m - 4,8 W/m - 416 lumen/m, dimbar - 12 V)

Automatisk avfrostning  
Ventilerad kylning  
Vibrationsdämpande system

Metal structure Aluminum door structure Wood / HPL  
/ MDF door frame 20 mm double glazing / Magnetic  
gasket Internal steel panel White natural daylight  
LED  
(4000 K - 60 led/mt - 4,8 W / mt - 416 lumen / mt dimmer - 12 V)

Automatic defrosting  
Ventilated refrigeration  
Anti-vibration system

## TERMoelekTRISKT KYLSYSTEM

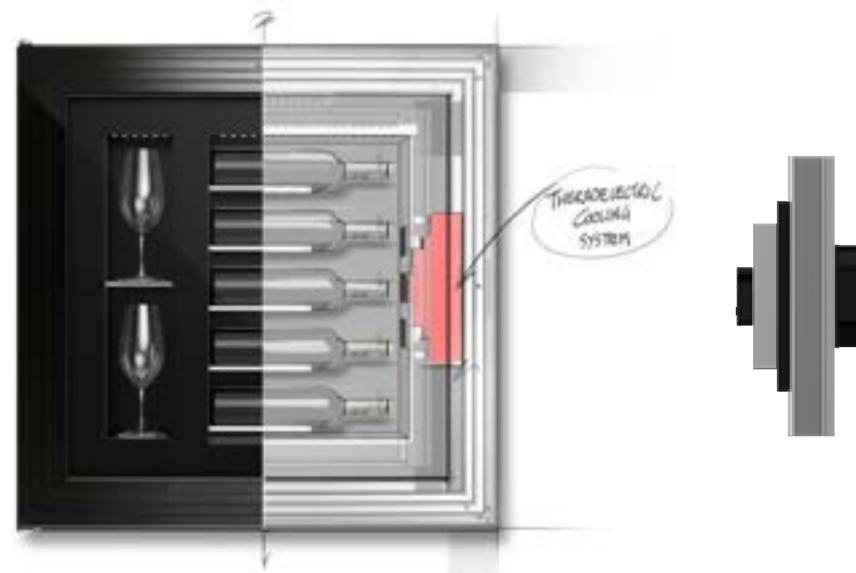

Designat och ingenjörsmässigt anpassat för specifikt bruk i Quadro Vino, är detta en renodlad miniatur av kylningsteknologi. Systemet använder termoelektrisk teknik. Anläggningen är miljövänlig, fri från skadliga gaser och tillverkad av helt återvinningsbara material.

Designed and engineered specifically for application on Quadro Vino, it is concentrated miniature cold technology. It employs a thermoelectrical system. It is a green system, free of polluting gases and built with entirely recyclable materials.

## MODELL • Model

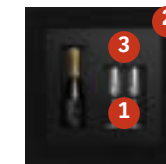

QV12

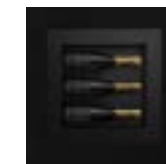

QV30



QV40



QV52

## 1 - STRUKTUR • Structure



Standard  
RAL 9005  
nero  
black  
N



Optional  
RAL 9010  
bianco  
white  
B

## 2 - RAMAR • Frames

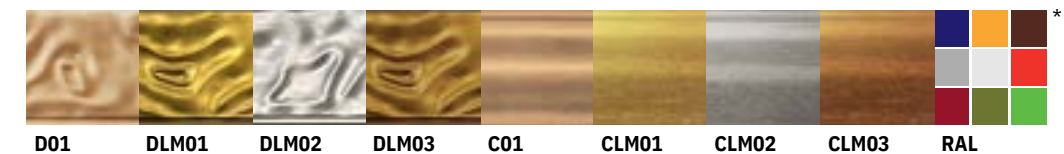
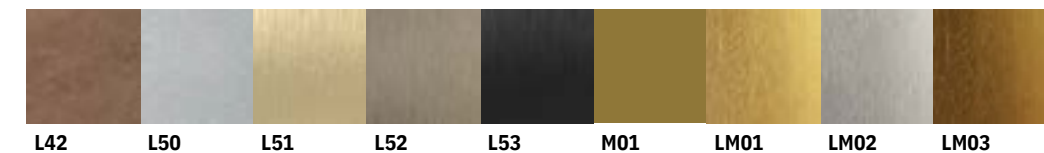
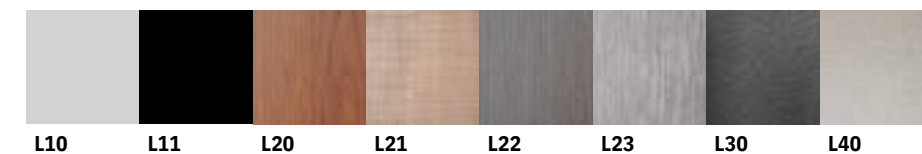

## 3 - PANEL • Panels

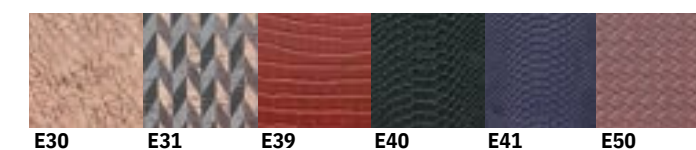
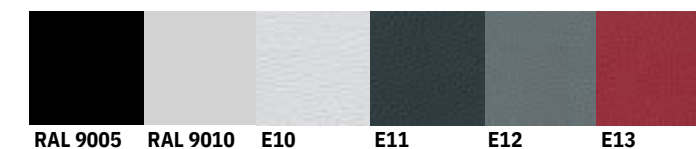























## LJUS FÄRG. • Light colour









○○○ Standard: LED vitt neutralt ljus • white natural daylight LED



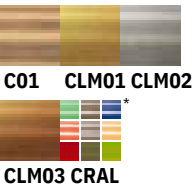



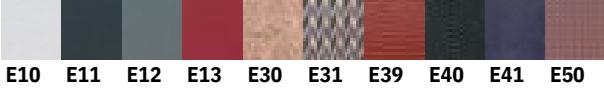

●●● Optional: LED blu • blue LED (OPT-QLB)

RAL-färger appliceras på MDF med en matt 20-gloss finish.

# Quadro VINO

CODE				N. 0,75 LT	H Ø		Class														
 QV12N	600 x 600 x 155	700 x 700 x 250	800 x 1000 x 390	1	H 324 Ø 105	3	SN-N	G	30	238	NW	29	100 - 240V	22	25	33	0,1	0,3	+4 / +6	+6 / +8	+8 / +10
 QV30N	600 x 600 x 155	700 x 700 x 250	800 x 1000 x 390	3	H 328 Ø 98	11	SN-N	G	60	194	NW	29	100 - 240V	22	25	33	0,1	0,3	+8 / +10	+10 / +12	+12 / +14
 QV40N	780 x 780 x 155	860 x 860 x 250	1000 x 1000 x 390	4	H 400 Ø 90	16	SN-N	G	60	182	NW	29	100 - 240V	30	39	45	0,2	0,4	+12 / +14	+14 / +16	+16 / +18
 QV52N	780 x 780 x 155	860 x 860 x 250	1000 x 1000 x 390	5	H 328 Ø 90	15	SN-N	G	60	198	NW	29	100 - 240V	30	39	45	0,2	0,4	+12 / +14	+14 / +16	+16 / +18

CODE							
QV1230C- 	•	•	•	600 x 600 x 10	2	18	0,02
QV4052C- 	•	•	•	780 x 780 x 10	2,5	20	0,02

CODE						
 QV12P-	•	•	540 x 540 x 1,2	-	-	-
 QV30P-	•	•	540 x 540 x 1,2	-	-	-
 QV40P-	•	•	715 x 715 x 1,2	-	-	-
 QV52P-	•	•	715 x 715 x 1,2	-	-	-

\* I colori RAL vengono realizzati su supporto di MDF in finitura opaca 20 gloss.  
\* RAL colours are made in MDF 20-gloss matte finish.

Le temperature riportate sono indicative e possono variare di (+ -) 2 °C. Rilevazioni effettuate con temperatura ambiente di 25 °C.  
Reported temperatures are approximate and may vary by (+ -) 2 °C. Detections made in 25 °C ambient temperature.

# FÄRGER



## HPL laminato alta pressione • High pressure laminate



**L10** bianco opaco  
matte white

**L11** nero opaco  
matte black

**L20** castagno  
chestnut

**L21** Teak Roble  
Teak Roble

**L22** wengé loft  
loft wenge

**L23** larice cenere  
ash larch

**L30** nero materico  
textured black

**L40** cemento tortora  
dove concrete

**L42** corten  
corten



**L50** acciaio satinato  
brushed steel

**L51** oro satinato  
satin gold

**L52** bronzo satinato  
satin bronze

**L53** nero satinato  
satin black

## MDF Verniciatura a liquido • Liquid paint finish



**M01** MDF non verniciato  
no finish MDF

**LM01** oro metallico liquido  
liquid metal gold

**LM02** argento metallico liquido  
liquid metal silver

**LM03** bronzo metallico liquido  
liquid metal bronze

**RAL 9005** nero opaco  
matte black

**RAL 9010** bianco opaco  
matte white

**RAL 20** opaco 20 gloss  
matte 20 gloss

## Dune Verniciatura a liquido • Liquid paint finish

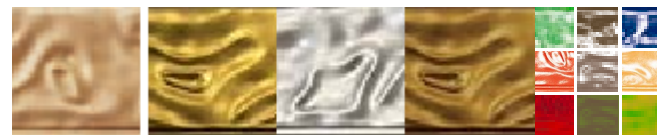

**D01** Dune non verniciato  
no finish Dune

**DLM01** oro metallico liquido  
liquid metal gold

**DLM02** argento metallico liquido  
liquid metal silver

**DLM03** bronzo metallico liquido  
liquid metal bronze

**DRAL 20** opaco  
matte

## Classica Verniciatura a liquido • Liquid paint finish



**C01** non verniciata  
no finish Classic

**CLM01** oro metallico liquido  
liquid metal gold

**CLM02** argento metallico liquido  
liquid metal silver

**CLM03** bronzo metallico liquido  
liquid metal bronze

**CRAL 20** opaco  
matte

## Ecopelle • Faux leather



**E10** ecopelle bianca  
white faux leather

**E11** ecopelle nera  
black faux leather

**E12** ecopelle grigia  
grey faux leather

**E13** ecopelle rossa  
red faux leather

**E39** ecopelle pitone  
red python faux leather

**E40** ecopelle rettile  
black faux reptile

**E41** ecopelle rettile  
black faux reptile

**E50** ecopelle intrecciata tabacco  
brown woven faux leather

## Sughero • Cork



**E30** sughero rete  
cork mesh

**E31** sughero spina di pesce  
cork herringbone

## Colorazioni speciali RAL • Special RAL colors



**RAL 1001** BEIGE

**RAL 1002** SAND YELLOW

**RAL 1003** SIGNAL YELLOW

**RAL 1006** MAIZE YELLOW

**RAL 1007** DAFFODIL YELLOW

**RAL 1011** BROWN BEIGE

**RAL 1014** IVORY

**RAL 1015** LIGHT IVORY

**RAL1019** GREY BEIGE

**RAL 1024** OCHRE YELLOW



**RAL 1034** PASTEL YELLOW

**RAL 2000** YELLOW ORANGE

**RAL 2003** PASTEL ORANGE

**RAL 2010** SIGNAL ORANGE

**RAL 3004** PURPLE RED

**RAL 3005** WINE RED

**RAL 3007** BLACH RED

**RAL 3009** OXIDE RED

**RAL 3012** BEIGE RED

**RAL 3017** ROSE



**RAL 3031** ORIENT RED

**RAL 4001** RED LILAC

**RAL 4004** CLARET VIOLET

**RAL 4009** PASTEL VIOLET

**RAL 5003** SAPPHIRE BLUE

**RAL 5004** BLACK BLUE

**RAL 5005** SIGNAL BLUE

**RAL 5008** GREY BLUE

**RAL 5012** LIGHT BLUE

**RAL 5014** PIGEON BLUE



**RAL 5020** OCEAN BLUE

**RAL 6005** MOSS GREEN

**RAL 6011** RESEDA GREEN

**RAL 6019** PASTEL GREEN

**RAL 7000** SQUIRREL GREEN

**RAL 7001** SILVER GREY

**RAL 7003** MOSS GREY

**RAL 7004** SIGNAL GREY

**RAL 7006** BEIGE GREY

**RAL 7011** IRON GREY



**RAL 7030** STONE GREY

**RAL 7032** PEBBLE GREY

**RAL 7035** LIGHT GREY

**RAL 7036** PLATINUM GREY

**RAL 7042** TRAFFIC GREY

**RAL 8002** SIGNAL BROWN

**RAL 8007** FAWN BROWN

**RAL 8014** SEPIA BROWN

**RAL 8017** CHOCOLATE BROWN

**RAL 8019** GREY BROWN



**RAL 8022** BLACK BROWN

**RAL 8025** PALE BROWN

**RAL 8028** TERRA BROWN

**RAL 9001** CREAM

**RAL 9002** GREY WHITE

**RAL 9003** SIGNAL WHITE

**RAL 9004** SIGNAL BLACK

**RAL 9005** JET BLACK

**RAL 9010** PURE WHITE

**RAL 9016** TRAFFIC WHITE

I colori stampati in questa cartella sono indicativi  
The colours printed and shown in this folder are merely indicative



## Legenda

Legend

CODE	Codice	Code
	Temperatura (Temperatura interna vano refrigerato)	Temperature (Internal temperature in refrigerated compartment)
	Temperatura ambiente (Umidità relativa 50%)	Ambient temperature (Relative humidity 50%)
	Versione	Versio n
	Refrigerato	Cooled
	Neutro	Neutral
	Riscaldato	Heated
	Ventole interne spente	Internal fans off
	Ventole interne accese	Internal fans on
	Rumorosità - Pressione acustica Leq (h 155 cm - d. 100 cm)	Noise level - Leq sound pressure level (h 155 cm - d. 100 cm)
	Tensione	Voltage
	Assorbimento	Absorption
<b>Class</b>	Classe climatica	Climate class
	Modello/tipologia compressore	Compressor type
<b>INV</b>	Compressore inverter	Inverter compressor
<b>FIX</b>	Compressore a giri fissi	Fixed-speed compressor
<b>HF</b>	Gas refrigerante	Refrigerant gas
	Quantità gas	Gas amount
	Numero piastre eutettiche	Number of eutectic plates
<b>LIGHT</b>	Luce	Light
<b>NW</b>	Led bianco naturale (4000 K - 60 led/mt - 4,8 W / mt - 416 lumen / mt - 12V)	White natural daylight LED (4000 K - 60 led/mt - 4,8 W / mt - 416 lumen / mt - 12V)
<b>WW</b>	Led bianco caldo (3000 K - 60 led/mt - 1,2 W / mt - 130 lumen / mt - 12V)	brightwhite warm LED (3000 K - 60 led/mt - 1,2 W / mt - 130 lumen / mt - 12V)
<b>BL</b>	Led blu	Blue LED
<b>RGB</b>	Controller RGB (60 led/mt - 14,4 W / mt - 24V)	RGB controller (60 led/mt - 14,4 W / mt - 24V)
<b>CCT</b>	Controller bianco dinamico (2700/6000 K - 140 led/mt - 19,2 W / mt - 2000 lumen / mt)	Dinamic white controller (2700/6000 K - 140 led/mt - 19,2 W / mt - 2000 lumen / mt)

	Cornice lineare	Linear frame
	Cornice Dune	Dune frame
	Cornice Classica	Classic frame
	Lato posteriore vetrina	Showcase back side
	Ante in vetro	Glass doors
	Pannello cieco	Blank panel
	Numero bottiglie	Number of bottles
	Altezza / diametro bottiglie	Bottle height / diameter
	Presente	Present
	Assente / dato non disponibile	Absent / data not available
	Volume interno	Internal volume
	Dimensioni nette	Net dimensions
	Dimensioni con imballo	Dimensions including packaging
	Dimensioni con imballo su pedana	Dimensions including packing on pallet
	Peso netto	Net weight
	Peso con imballo	Weight with packaging
	Peso con imballo su pedana	Weight with packing on pallet
	Volume con imballo	Volume with packaging
	Volume con imballo su pedana	Volume with packaging on pallet
	Imballo in legno	Wooden packaging
<b>DS</b>	Descrizione	Description
	Dimensione ventola	Fan blade size
	Ø mm - Connessioni (liquido - aspirazione)	Ø mm - Connections (liquid - suction)